

IKO TGX SYSTEM

PRODUCT INFORMATION

The IKO TGX roofing membranes are produced using polyester and glass reinforcements having exceptional dimensional stability.

SBS modified bitumen coatings provide a good high temperature performance, and resistance to damage and marking during application.

Product Code	
TGX Underlay	MW170700
TGX Capsheet:	
Green	MW170702
Black	MW170703
Brown	MW170704



USE

These products can be used to provide built-up flat roofing solutions in both domestic and commercial situations.

INDEPENDENT ACCREDITATION



0086-CPD-537586

The product carries a Declaration of Performance Certificate.

FEATURES & BENEFITS

SBS Modification – greater flexibility under ambient temperature fluctuations

Polyester Capsheet base carrier – strong robust cap sheet material

Robust – system carries a 10 year material guarantee

PERFORMANCE & COMPOSITION

TGX Underlay

Composition:	SBS Bitumen
Form:	Roll
Finish:	Sand
General Dimension Data	
Length:	16m
Width:	1m
Mass/Weight:	2kg/m ²
Roll Weight:	32 kg
Carrier:	Glass

TGX Capsheet

Composition:	SBS Bitumen
Form:	Roll
Colour:	Green, Black, Brown
General Dimension Data	
Length:	8m
Width:	1m
Mass/Weight:	4kg/m ²
Roll Weight:	32 kg
Carrier:	Polyester

SPECIFICATION

All construction detailing and specification should conform to UK Building Regulations.

Relevant Codes of Practice and British Standards, should also be used for guidance, in particular it is recommended that reference is made to the relevant parts of:

BS 8747:2007 Reinforced bitumen membranes for roofing – Guide to selection and specification;
BS 8217:2005 Code of Practice for Reinforced Bitumen Membranes for roofing;
BS 6229:2003 Code of Practice for Flat Roofs with continuously supported roof coverings;
BS5250:2011 Code of Practice Control of Condensation within Buildings.

Refurbishment work undertaken on existing flat roofs is likely to be reportable to Local Authority Building Control (LABC) and it is advisable that any proposed works are discussed with the LABC prior to commencement, unless the installing contractor is a member of the Competent Roofer Scheme.
www.competentroofer.co.uk

Where required by building warranty providers i.e. NHBC, LABC, etc. installers and those undertaking specifications should seek guidance from Technical Standards as issued by the provider in addition to the above.

The National Federation of Roofing Contractors (NFRC) also provides a Responsible Specification Checklist that may be useful during this stage –
www.nfrc.co.uk

DESIGN CONSIDERATIONS

CONFIGURATION

The construction of the roof deck and ceiling has an important effect on the behaviour of the waterproofing material on top.

The building industry uses the terms WARM ROOF and COLD ROOF to describe the two different types.

Most roofs require insulation and current practice is for insulation to be placed above the roof deck, often referred to as a 'warm roof'. No void ventilation is required with this design.

Alternative practice is to install the insulation within the voids below the roof deck. Often referred to as a 'cold roof', this type of arrangement must include ventilation to the void areas to remove the risk of condensation.

It is advisable that cold roof design is ventilated at the rates prescribed within the aforementioned British Standards and Approved Codes of Practice.

STRUCTURAL DECKS

It is essential that the deck is suitably fit for purpose and is structurally adequate in supporting the waterproofing system and any associated loadings.

For deck selection and determining suitability, the guidance of the relevant Approved Codes of Practice should be sought.

FALLS AND DRAINAGE

To reduce the effect of water ponding on the roof finish, a minimum finished fall of **1:80** should be achieved; however designs should be to 1:60 to take into account any inaccuracies within the deck construction.

VAPOUR CONTROL

It is essential that roofing solutions include layers to control and inhibit the movement of vapour into the building fabric. For further guidance please contact IKO Technical services department.

WARM ROOF

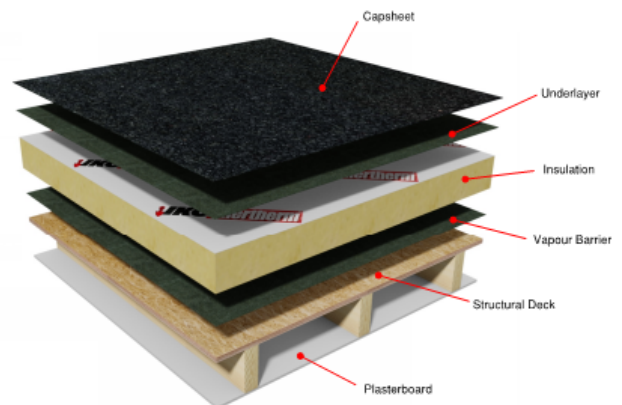

COLD ROOF

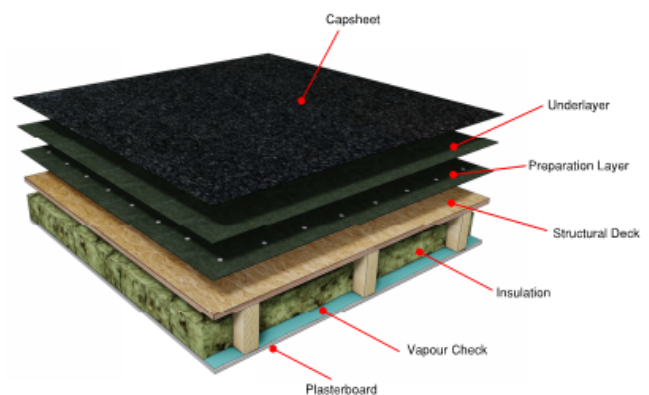

CONSTRUCTION

MATERIAL HANDLING

Checking: Material should be checked to ensure that they conform to the project specification.

Handling: Material should be unloaded and handled with care to avoid damage.

Site Storage: Material should be stored on end on a firm, clean base protected from direct sunlight.

PRIOR TO COMMENCEMENT

Application must always follow good, safe working practice.

Prior to commencing works, it is advisable to consult Health and Safety Executive Guidance documents such as HSG33 'Health and Safety in Roof Work', irrespective of levels of competence, to ensure all works are being planned and undertaken in a safe, pragmatic manner.

Torch applied materials should only be applied by those competent, conversant and capable of undertaking roofing works safely and that are experienced in the use of roofing torches and procedures.

Torch applied membranes should not be used in close proximity to combustible materials, decorative coatings and heat sensitive materials.

Roofing contractors should be fully conversant with the guidance of the National Federation of Roofing Contractors (NFRC) 'Safe2Torch' campaign.

PREPARATION

Before commencement of the roofing works, the roofing contractor should ensure that the surfaces to receive the new waterproofing system are sound and capable of accepting the imposed loading of the new waterproofing system and its installation.

Existing deck substrates should be assessed by a competent roofer or suitably qualified professional to ascertain their suitability in relation to structural strength, falls and drainage provision.

The deck surface to which the waterproofing membrane is to be installed must be clean, dry and fit for purpose.

SETTING OUT

When setting out the field area, the rolls of material should always be laid in the same direction, never cross bonded.

Top layers should be arranged to achieve a staggered bond with the preceding underlayers with half width layers being used to maintain bond patterns where necessary.

Sheets should be overlapped to form the required 75mm side laps and 100mm ends laps. End laps must be staggered so that they do not occur in the same position in adjacent sheets.

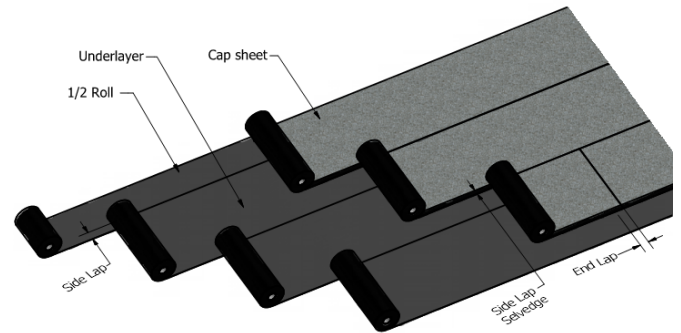

Figure 1 Setting Out to Staggered Laps

BONDING

The membrane must be fully bonded by using the torch-on application method, ensuring that a constant flow of bitumen is maintained across the whole width of the roll and that a bead of bitumen (5-15mm) is exuded from all side and end laps to demonstrate a good seal has been achieved (Figure 2).

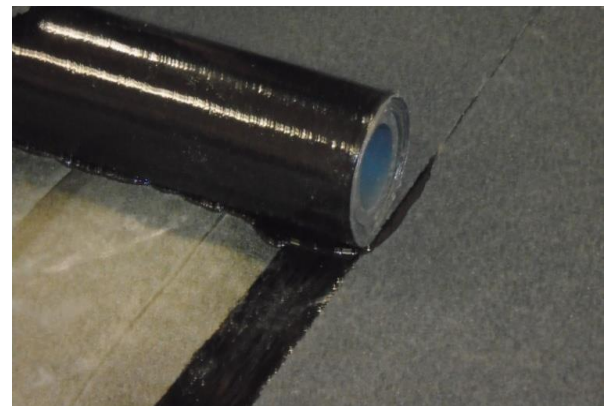
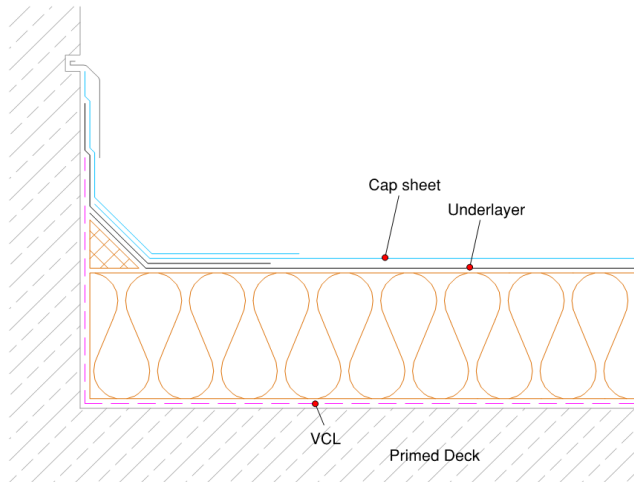

Figure 2 Side Lap Formation

DETAILING

All waterproofing detailing must be undertaken as separate flashings.

Upstands and skirtings – (Warm Roof)



At all skirtings and upstands, the waterproofing should be at least 150mm above the level of the finished roof. Care must be undertaken not to bridge over any DPC or Cavity Tray positions.

Drip edge detail – (Warm Roof)

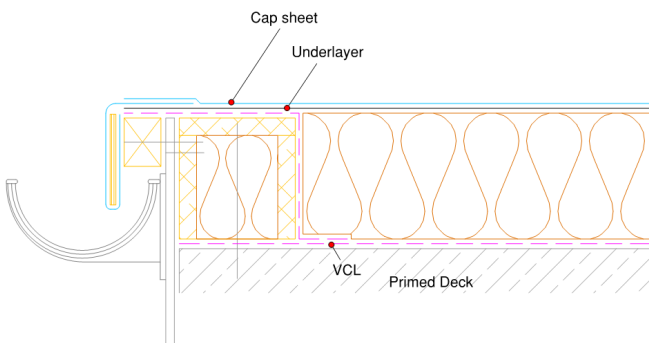

A welted drip edge should be formed wherever drainage to an external guttering is required. A plywood former should be introduced to form the drip.

In warm roof build ups an insulated hard edge, 10mm thinner than the insulation thickness, should be incorporated.

Check kerb – (Warm Roof)

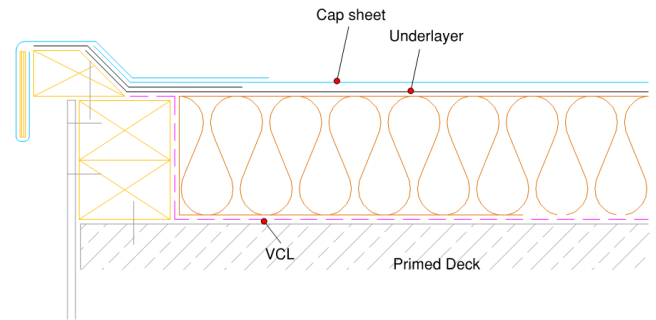

Check kerbs should be constructed to form a 50mm water check to prevent water from running over the edge incorporating a welted drip detail. In warm roof build ups a timber hard edge should be incorporated.

Other typical details are available via the IKO website, or alternatively via NFRC information sheets – www.nfrc.co.uk

POST COMPLETION

To obtain the best possible life expectancy, all flat roofs should be inspected in accordance with the requirements of BS 6229 Code of Practice for Flat Roofs with continuously supported roof coverings.

DURABILITY

When installed as a complete built up roof system and conditions are maintained as per IKO literature, relevant Codes of Practice and UK Building Regulations, the TGX system has a 10 year material guarantee.

DISCLAIMER

Whilst every precaution is taken to ensure that the information given in this literature is correct and up to date it is not intended to form part of any contract or give rise to any collateral liability, which is hereby specifically excluded.

IKO reserve the right to amend and/or withdraw this document without notice.

Intending purchasers of our materials should therefore verify with the company whether any changes in our specification, application details, withdrawals or otherwise have taken place since this literature was issued.